

HBL HIGHBAY LINEAR Z10

PROJECT: _____

SCHEDULE: _____ DATE: _____

PREPARE BY: _____

NOTES: _____

DESCRIPTION

naturaLED® offers the perfect solution for your lighting needs with our Linear High/Low Bay. This new design allows us to optimize all the beneficial characteristics of LED light in a high-performance fixture that will endure many years of service. These Linear High Bays are extremely durable, yet lightweight, with excellent thermal design. Included with Z10 receptacle-ready. This product is a hybrid crossover, which makes it an excellent fixture for new construction and/or as a replacement solution for your existing High/Low Bays needs.









APPLICATIONS

Warehouses, Parking Garages, Offices, Factories, Hospitals, Hotels

FEATURES

- DLC Premium
- Damp Location
- ETL/cETL Listed
- Selectable Wattages
- Color Temp: 3CCT (35/40/50K)
- Voltage: 120-277V, 120-347V
- Powerfactor >0.9
- Beam Angle: 100°
- Dimmable: 0-10V
- CRI: 80
- Operating temperature: - 40°F - 122°F
- Z10 Receptacle included
- Excellent thermal design / Select binning for consistent color
- Minimum glare with diffused polycarbonate lens
- Available in 12"x22" and 12"x44" configurations
- Material: extruded aluminum housing and epoxy powder coat
- 5Year Warranty
- Optional for purchase: yoke mount, motion sensor, photocell, emergency driver

ACCESSORIES

-  Emergency Driver
-  Z10 Receptacle & Sensors
-  Yoke Mount
-  WireGuard
-  Remote Controller
-  Pendant Mount
-  Surge Protector

SAMPLE NUMBER HBL/150S/22FR/8C3-Z10

SERIES	WATTAGE	LENGTH	LENS	CR/COLOR TEMP	RECEPTACLE
HBL High Bay Linear	150S <150 Selectable Wattage	22 22-inch	FR Frosted	8C3 CRI 80 Selectable Color Temp	Z10 Z10 Included



ORDERING

(P=Premium / S=Standard)

Watts (W)	Ordering Code	Description	CCT (K)	Lumens (Lm)	Equiv. Wattage (W)	Voltage	Damp Location	DLC (P/S)
90	9687	HBL/150S/22FR/8C3-Z10	3CCT	12,150	400-575	120-277	•	P
120			(35/40/50K)	16,200				
150				20,250				
150	9688	HBL/300S/44FR/8C3-Z10	3CCT	20,250	575-1000	120-277	•	P
240			(35/40/50K)	32,400				
300				40,500				
90	9689	HBL/150S/22FR/8C3/347-Z10	3CCT	12,150	400-575	120-347	•	P
120			(35/40/50K)	16,200				
150				20,250				
150	9690	HBL/300S/44FR/8C3/347-Z10	3CCT	20,250	575-1000	120-347	•	P
240			(35/40/50K)	32,400				
300				40,500				

ACCESSORIES (Ordered Separately)



Z10 Receptacle (Included)
P10518 REC-Z10-WH
(Z10 receptacle with white cap)



Z10 Sensors
P10520 SEN-ANT-5-Z10-PC
(Z10 Photocell)

P10521 SEN-ANT-5-Z10
(Z10 Microwave Sensor w/Photocell)

P10522 SEN-ANT-6-Z10
(Z10 PIR Sensor w/Photocell)



Remote Programmer
P10316 SEN-BRI-RC100
(Remote Programmer for P10521, P10522)



Yoke Mount
P10092 MT-YK-HBL22
(Yoke Mount for 2-ft Linear High Bay)

P10093 MT-YK-HBL44
(Yoke Mount for 4-ft Linear High Bay)



Emergency Driver
7341 BAEM20-260BC/347-A
(20W 90-260Vdc LED Emergency Driver 120-347V)



7342 BAEM40-170BC/347-C
(40W Micro Inverter 120-347V)



Wireguard
P10576 WG-HBL22/WH-G1
(Wireguard for 22" HBL)

P10577 WG-HBL44/WH-G1
(Wireguard for 44" HBL)



Pendant Mount (1/2" & 3/4" NPT)
P10578 ADP-PM-HBL/WH-G1
(1/2" and 3/4" NPT Pendant Mount)



Surge Protector
P10389 SPD-L-10KV-277
(Surge Protection 10KV 120-277V)



P10390 SPD-L-20KV-277
(Surge Protection 20KV 120-277V)

DIMENSIONS

12" x 22"
5.51-lbs

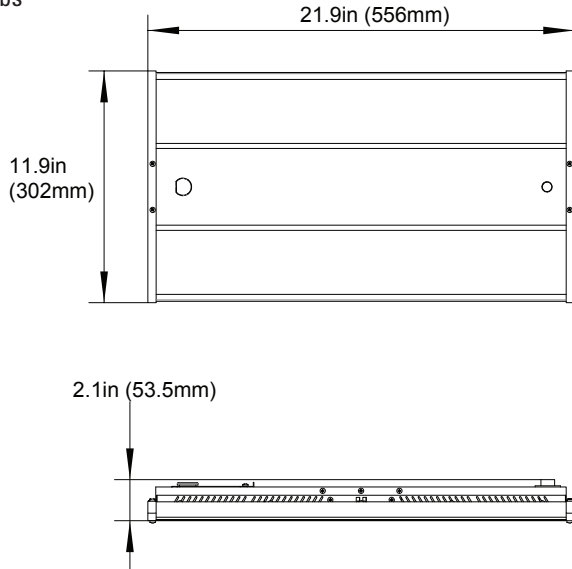

12" x 44"
12.12-lbs

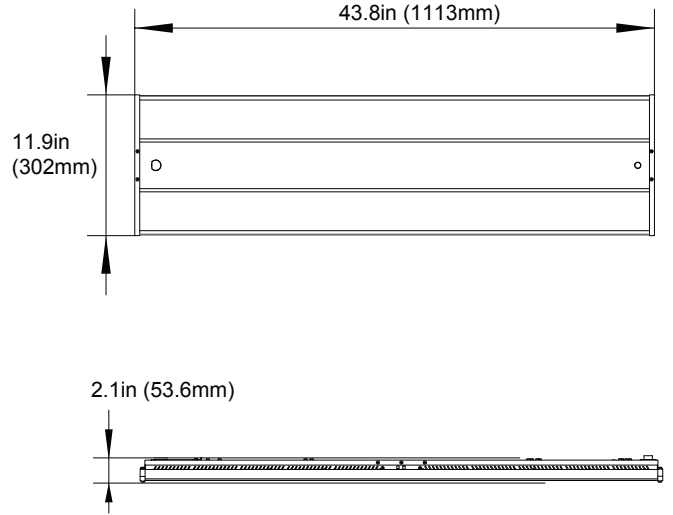

PHOTOMETRICS CHART

12" x 22"

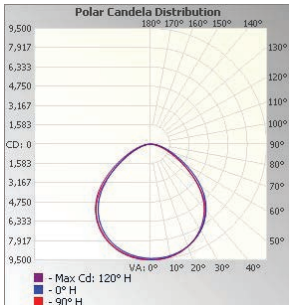

Center Beam fc	Beam Width	
5.0R	375 fc	12.6 ft 12.2 ft
10.0R	93.8 fc	25.1 ft 24.5 ft
15.0R	41.7 fc	37.7 ft 36.7 ft
20.0R	23.4 fc	50.3 ft 49.0 ft
25.0R	15.0 fc	62.9 ft 61.2 ft
30.0R	10.4 fc	75.4 ft 73.5 ft

Vert. Spread: 103.0°
Horiz. Spread: 101.5°

12" x 44"

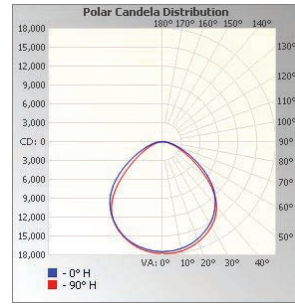

Center Beam fc	Beam Width	
5.0R	701 fc	13.0 ft 11.7 ft
10.0R	175 fc	26.0 ft 23.3 ft
15.0R	77.9 fc	39.0 ft 35.0 ft
20.0R	43.8 fc	52.0 ft 46.7 ft
25.0R	28.0 fc	65.0 ft 58.3 ft
30.0R	19.5 fc	78.0 ft 70.0 ft

Vert. Spread: 104.9°
Horiz. Spread: 98.6°

PACKAGE

Case Qty 2 pcs per pack

