

PROJECT: _____

SCHEDULE: _____ DATE: _____

PREPARE BY: _____

NOTES: _____

RTF RETROFIT TROFFER

DESCRIPTION

naturaLED® Retrofit Troffer is the perfect solution for your interior lighting needs. The troffers come in 2'x2' and 2'x4' for Tbar/Grid ceilings and are designed for easy installation and maximum energy savings. The mounting can fit for both 1" and 9/16" T-bar grids. All troffers are available in DLC premium and up to 5,250 lumens with excellent consistent color.

Access to open and lock

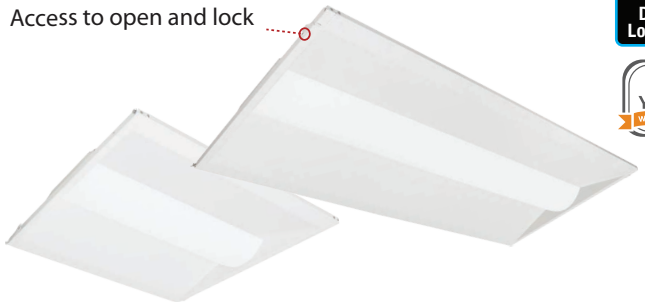

APPLICATIONS

Conference, Meeting Rooms, Factories, Offices, Schools, Hospitals

Rated Life Hours 50,000
Warranty 5 Years

FEATURES

- DLC Standard
- Damp Location
- Color Temp: 3500K, 4000K
- Voltage: 120-277V
- Power Factor: >0.9
- Surge Protection: 2.5KV
- Beam Angle: 110°
- Dimmable: 1-10V
- CRI: >80
- Operating temperature: - 4°F - 104°F
- Easy installation for retrofit replacement
- Available in 2' or 4' length
- Material: Steel and PC lens
- 5Year Warranty

Retrofit Troffer designed for T-Bar Grid ceilings with easy installation

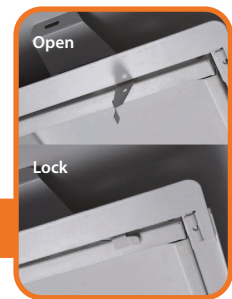

Easy access to open and lock

SAMPLE NUMBER LED-FXRTF25/2x2/835

STYLE	FAMILY	SERIES	WATTAGE	LENGTH	CRI	COLOR TEMP
LED	FX	RTF	25	2x2	8	35
LED Lighting	Fixture	Retrofit Troffer	25 Watt	2-ft x 2-ft	CRI 80	3500K



RETROFIT TROFFER

CEILING & AREA LUMINAIRES

*P= Premium DLC / *S = Standard DLC

ORDERING

Watts (W)	Ordering Code	Description	CCT (K)	Lumens (Lm)	Size	Equiv. Wattage (W)	Damp Location	DLC (S/P)
25	7779	LED-FXRTF25/2X2/835	3500K	3,125	2'x2'	60-70	•	S
25	7780	LED-FXRTF25/2X2/840	4000K	3,125	2'x2'	60-70	•	S
30	7704	LED-FXRTF30/2X4/835	3500K	3,900	2'x4'	90-100	•	S
30	7705	LED-FXRTF30/2X4/840	4000K	3,900	2'x4'	90-100	•	S
42	7781	LED-FXRTF42/2X4/835	3500K	5,250	2'x4'	>100	•	S
42	7782	LED-FXRTF42/2X4/840	4000K	5,250	2'x4'	>100	•	S

DIMENSIONS

2'x2' - 25 Watt
8.82-lbs

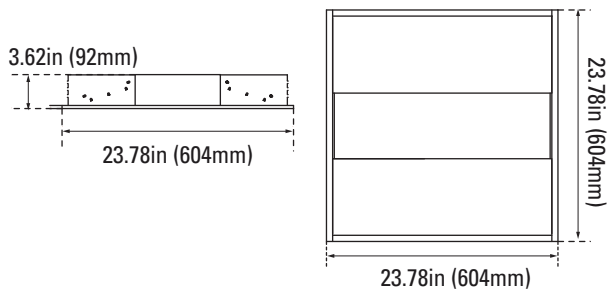

2'x4' - 30/42 Watt
16.76-lbs

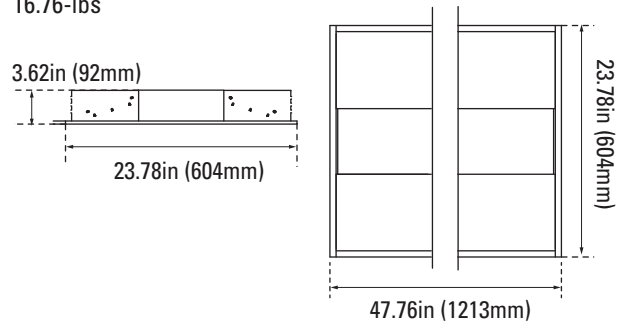

INSTALLATION

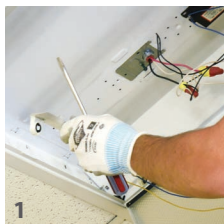

1
Remove existing hardware

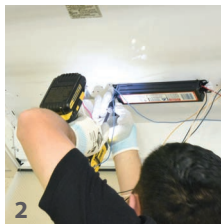

2
Remove ballast



3
Install Troffer Retrofit end brackets to each end



4
Slide Troffer into the slot

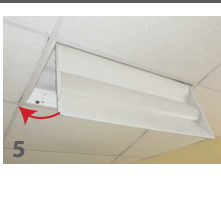

5
Ensure the installation is secure

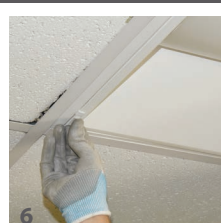

6
Secure door body by locking the latches

PHOTOMETRICS CHART

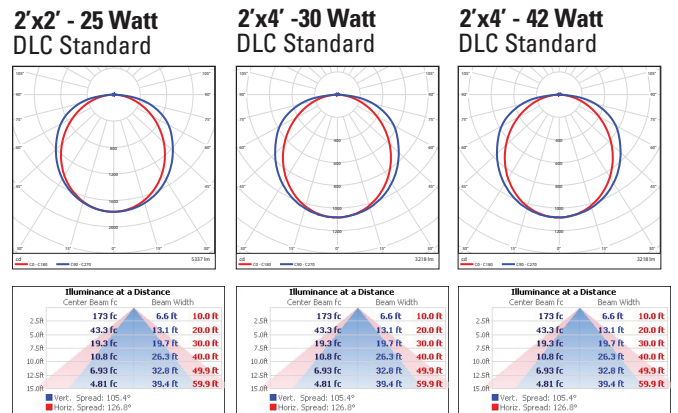

PACKAGE

Case Qty 1 pc

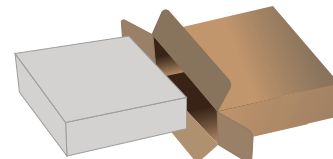

* Please refer to LED Retrofit Troffer Installation Guide