

SPL SPORTS LIGHT 16" (IP66)

PROJECT: _____

SCHEDULE: _____ DATE: _____

PREPARE BY: _____

NOTES: _____

DESCRIPTION

When you watch or participate in live sporting events, you don't want to miss one second of the action. NaturaLED® gives everyone a chance to catch the game by providing bright, broadly distributed lighting with our high-performance sports light.

The superior quality of our DLC premium qualified sports fixture provides crisp, glare-free lighting, and at 650W providing 95,000 lumens can help athletes execute at peak levels. Upgrading the lighting in your sports facility can improve the feeling of safety for your guests, protect valuables and property, and increase the sense of community.

APPLICATIONS

Universities, School Stadium, Parks, Recreation Centers, Municipal Locations

FEATURES

- DLC Premium Qualified
- IP66 Rated
- ETL Listed
- ColorTemp: 4000K, 5000K
- Voltage: 120-277V, 277-480V
- Power Factor >0.9
- Surge Protection: 20KV
- Dimmable: 0-10V
- CRI: >80
- Operating temperature: - 40°F - 158°F
- Designed with thermal management to maximize heat dissipation
- 16" Compact design for simpler installation
- UV resistant polycarbonate lens
- Type II, III, IV, V beam distribution available
- Color: Black
- 10 Year Limited Warranty*
- Optional for Purchase: Laser Pointer, Lens, Remote Driver Cable, Slip Fitter Mount



ACCESSORIES

- Slip fitter mounting arm
- Laser pointer
- 30-ft remote driver cable
- Lens - Type 3, 4, 5

SAMPLE NUMBER FX16SPL400/33/840/BK/480

FAMILY	DIAMETER	SERIES	WATTAGE	TYPE	CRI/ COLOR TEMP	COLOR	VOLTAGE
FX	16	SPL	400	33	840	BK	480
Fixture	16-inch	Sports Light	400 Watt	33 Type III 44 Type IV 55 Type V	CRI 80 4000K	Black	277-480V



SPORTS LIGHT 16" (IP66)

SPORT & AREA LUMINAIRES

ORDERING

*P= Premium DLC / *S = Standard DLC

Watts (W)	Ordering Code	Description	CCT (K)	Lumens (Lm)	Equiv. Wattage (W)	Voltage	Beam Angle	IP66 Rated	DLC (S/P)
415	9474	FX16SPL400/44/850/BK	5000K	61,389	1,000	120-277V	4x4	•	P
410	*9395	FX16SPL400/33/840/BK/480	4000K	61,173	1,000	277-480V	3X3	•	P
410	*9323	FX16SPL400/33/850/BK/480	5000K	61,173	1,000	277-480V	3X3	•	P
412	*9396	FX16SPL400/44/840/BK/480	4000K	60,039	1,000	277-480V	4X4	•	P
412	9390	FX16SPL400/44/850/BK/480	5000K	58,826	1,000	277-480V	4X4	•	P
404	*9397	FX16SPL400/55/840/BK/480	4000K	60,751	1,000	277-480V	5X5	•	P
404	*9391	FX16SPL400/55/850/BK/480	5000K	58,826	1,000	277-480V	5X5	•	P
655	9475	FX16SPL650/44/850/BK	5000K	97,099	1,500	120-277V	4x4	•	P
655	*9399	FX16SPL650/33/840/BK/480	4000K	95,205	1,500	277-480V	3X3	•	P
655	*9324	FX16SPL650/33/850/BK/480	5000K	95,205	1,500	277-480V	3X3	•	P
654	9400	FX16SPL650/44/840/BK/480	4000K	95,020	1,500	277-480V	4X4	•	P
654	9392	FX16SPL650/44/850/BK/480	5000K	95,683	1,500	277-480V	4X4	•	P
657	*9401	FX16SPL650/55/840/BK/480	4000K	95,720	1,500	277-480V	5X5	•	P
657	*9393	FX16SPL650/55/850/BK/480	5000K	95,720	1,500	277-480V	5X5	•	P

*item made to order

ACCESSORIES (Ordered Separately)

Laser Pointer



P10305 LASER-SPL/GRN
(Laser Position Light)

Cable



P10230 PWC-300V2-30ft
(30-ft cable for remote driver)

Slip Fitter



P10307 MT-SF-16SPL/BK
(Slip Fitter Mount for 16SPL)

Lens - Type 3, Type 4, Type 5



P10296 LENS-SPL16-NEMA33/G1
(Type 3 Lens for 16SPL)



P10297 LENS-SPL16-NEMA44/G1
(Type 4 Lens for 16SPL)



P10298 LENS-SPL16-NEMA55/G1
(Type 5 Lens for 16SPL)

DIMENSIONS

400W **650W**
65-lbs 68-lbs

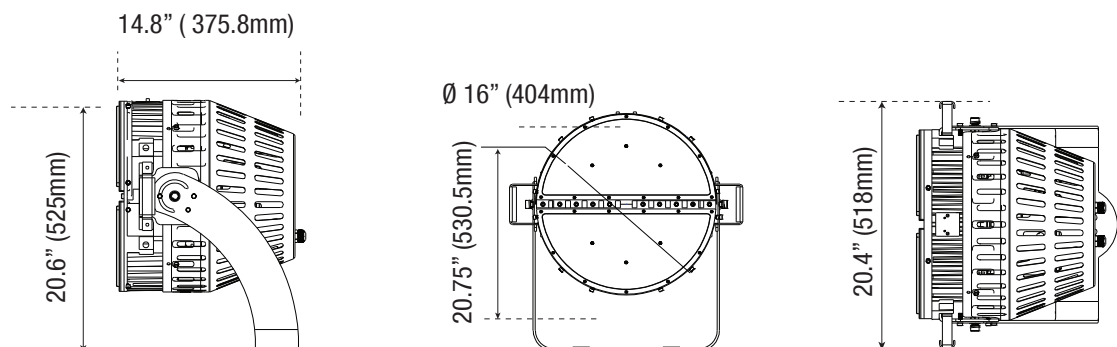

BEAM ANGLE NEMA TYPE AND BEAM SPREAD

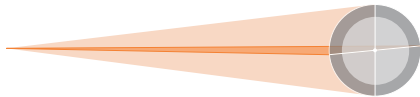
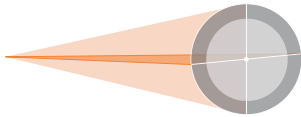
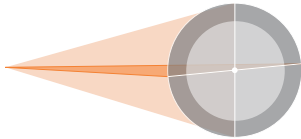
BEAM SPREAD	NEMA TYPE	BEAM SPREAD	DESCRIPTION
	3x3 Medium Narrow	29° - 46°	The medium narrow spot distribution is ideal for applications where beam light is needed but require a wider in distribution compared to NEMA 2x2 beam spread.
	4x4 Medium	46° - 70°	Setting a medium perfect for landscape and facade lighting with farther setbacks but providing a concentrated distribution.
	5x5 Medium Wide	70° - 100°	Wide distribution designed where applications required for wider pattern of lights. The medium flood is ideal for perimeter, architectural, signs, and general landscapes applications.

PHOTOMETRICS CHART

400 Watt (3X3 Lens)
DLC Premium

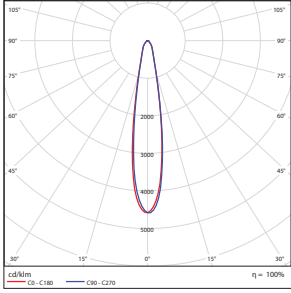

	Center Beam fc	Beam Width
2.5R	39,680 fc	0.8 ft 0.8 ft
5.0R	9,920 fc	1.7 ft 1.6 ft
7.5R	4,409 fc	2.5 ft 2.4 ft
10.0R	2,480 fc	3.3 ft 3.3 ft
12.5R	1,587 fc	4.2 ft 4.1 ft
15.0R	1,102 fc	5.0 ft 4.9 ft

Vert. Spread: 18.9°
Horiz. Spread: 18.5°

400 Watt (4X4 Lens)
DLC Premium

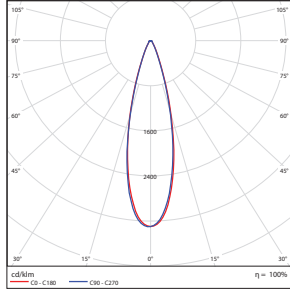

	Center Beam fc	Beam Width
2.5R	28,102 fc	1.2 ft 1.2 ft
5.0R	7,025 fc	2.5 ft 2.4 ft
7.5R	3,122 fc	3.7 ft 3.6 ft
10.0R	1,756 fc	4.9 ft 4.8 ft
12.5R	1,124 fc	6.1 ft 6.1 ft
15.0R	781 fc	7.4 ft 7.3 ft

Vert. Spread: 27.6°
Horiz. Spread: 27.3°

400 Watt (5X5 Lens)
DLC Premium

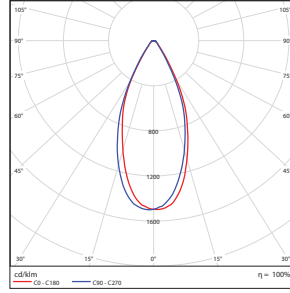

	Center Beam fc	Beam Width
2.5R	12,451 fc	2.1 ft 2.1 ft
5.0R	3,113 fc	4.1 ft 4.2 ft
7.5R	1,383 fc	6.2 ft 6.3 ft
10.0R	778 fc	8.2 ft 8.3 ft
12.5R	498 fc	10.3 ft 10.4 ft
15.0R	346 fc	12.3 ft 12.5 ft

Vert. Spread: 44.7°
Horiz. Spread: 45.3°

650 Watt (3X3 Lens)
DLC Premium

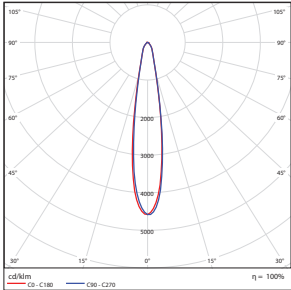

	Center Beam fc	Beam Width
2.5R	58,187 fc	0.8 ft 0.8 ft
5.0R	14,547 fc	1.6 ft 1.6 ft
7.5R	6,465 fc	2.5 ft 2.4 ft
10.0R	3,637 fc	3.3 ft 3.3 ft
12.5R	2,327 fc	4.1 ft 4.1 ft
15.0R	1,616 fc	4.9 ft 4.9 ft

Vert. Spread: 18.7°
Horiz. Spread: 18.5°

650 Watt (4X4 Lens)
DLC Premium

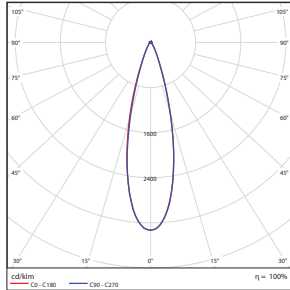

	Center Beam fc	Beam Width
2.5R	47,226 fc	1.2 ft 1.2 ft
5.0R	11,807 fc	2.5 ft 2.4 ft
7.5R	5,247 fc	3.7 ft 3.6 ft
10.0R	2,952 fc	4.9 ft 4.8 ft
12.5R	1,889 fc	6.1 ft 6.1 ft
15.0R	1,312 fc	7.4 ft 7.3 ft

Vert. Spread: 27.6°
Horiz. Spread: 27.3°

650 Watt (5X5 Lens)
DLC Premium

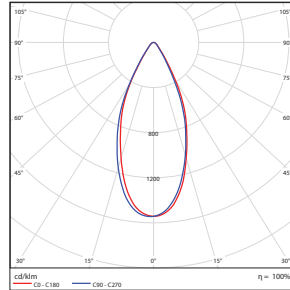

	Center Beam fc	Beam Width
2.5R	21,754 fc	2.0 ft 2.1 ft
5.0R	5,438 fc	4.1 ft 4.1 ft
7.5R	2,417 fc	6.1 ft 6.2 ft
10.0R	1,360 fc	8.1 ft 8.3 ft
12.5R	870 fc	10.1 ft 10.3 ft
15.0R	604 fc	12.2 ft 12.4 ft

Vert. Spread: 44.1°
Horiz. Spread: 44.8°

PACKAGE

Case Qty 1 pc

